

V _{RSM}	V _{RRM}	I _{FRMS} (maximum value for continuous operation)		
		175 A	310 A	310 A
V	V	I _{FAV} (sin. 180; T _{case} = . . .)		
		100 A (85 °C)	160 A (95 °C)	160 A (95 °C)
500	400	SKKD 100/04	–	–
900	800	SKKD 100/08	SKKD 162/08	SKKE 162/08
1300	1200	SKKD 100/12	SKKD 162/12	SKKE 162/12
1500	1400	SKKD 100/14	SKKD 162/14	SKKE 162/14
1700	1600	SKKD 100/16	SKKD 162/16	SKKE 162/16
1900	1800	SKKD 100/18	SKKD 162/18	SKKE 162/18
2100	2000	–	SKKD 162/20	SKKE 162/20
2300	2200	–	SKKD 162/22	SKKE 162/22

Rectifier Diode Modules

SEMIPACK® 1
SKKD 100 **SKMD 100¹⁾**

SEMIPACK® 2
SKKD 162 **SKND 162¹⁾**
SKKE 162



Symbol	Conditions	SKKD 100	SKKD 162 SKKE 162	Units
I _{FAV}	sin. 180; T _{case} = 85 °C	100	195	A
I _D ¹⁾	B2/B6 T _{amb} = 45 °C; P 3/180 T _{amb} = 35 °C; P 3/180 F P 16/200 F	73 / 91	90 / 115	A
		150 / 190	210 / 260	A
		–	320 / 425	A
I _{FSM}	T _{vj} = 25 °C; 10 ms	2 500	6 000	A
	T _{vj} = 125 °C; 10 ms	2 000	5 000	A
i ² t	T _{vj} = 25 °C; 8,3 ... 10 ms	31 250	180 000	A ² s
	T _{vj} = 125 °C; 8,3 ... 10 ms	20 000	125 000	A ² s
I _{RD}	T _{vj} max.; V _{RD} = V _{RRM}	5	9	mA
V _F	T _{vj} = 25 °C; (I _F = . . .); max.	1,35 (300 A)	1,5 (500 A)	V
V _(TO)	T _{vj} max	0,85	0,85	V
r _T	T _{vj} max	1,3	1,2	mΩ
R _{thjc}	} per diode / per module ²⁾	0,35 / 0,175	0,18 / 0,09	°C/W
R _{thch}		0,2 / 0,1	0,10 / 0,05	°C/W
T _{vj}		– 40 ... + 125	– 40 ... + 135	°C
T _{stg}		– 40 ... + 125	– 40 ... + 135	°C
V _{isol}		a. c. 50 Hz; r.m.s.; 1 s/1 min to heatsink to terminals } SI (US) units	3600 / 3000 5 (44 lb. in.) ± 15 %	
M ₁		3 (26 lb. in.) ± 15 % ³⁾	5 (44 lb. in.) ± 15 % ³⁾	Nm
M ₂				
a		5 · 9,81	5 · 9,81	m/s ²
w	approx.	95	250	g
Case	→ page B 1 – 95; 96	SKKD 100: A 10 (B 1 – 38: SKMD 100: A 33)	SKKD 162: A 23 SKKE 162: A 24 SKND 162: A 57	

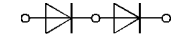

SKKD



SKKE

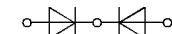

SKMD

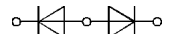

SKND

Features

- Heat transfer through aluminium oxide ceramic isolated metal baseplate
- Hard soldered joints for high reliability
- **SKKD** half bridge connection
center-tap connections:
SKMD common cathode
SKND common anode
- UL recognized, file no. E 63 532

Typical Applications

- Non-controllable rectifiers for AC/AC converters
- Line rectifiers for transistorized AC motor controllers
- Field supply for DC motors
- **SKKE**: Free-wheeling diodes

¹⁾ SKMD 100, SKND 162 available on request

²⁾ SKKD types only

³⁾ See the assembly instructions

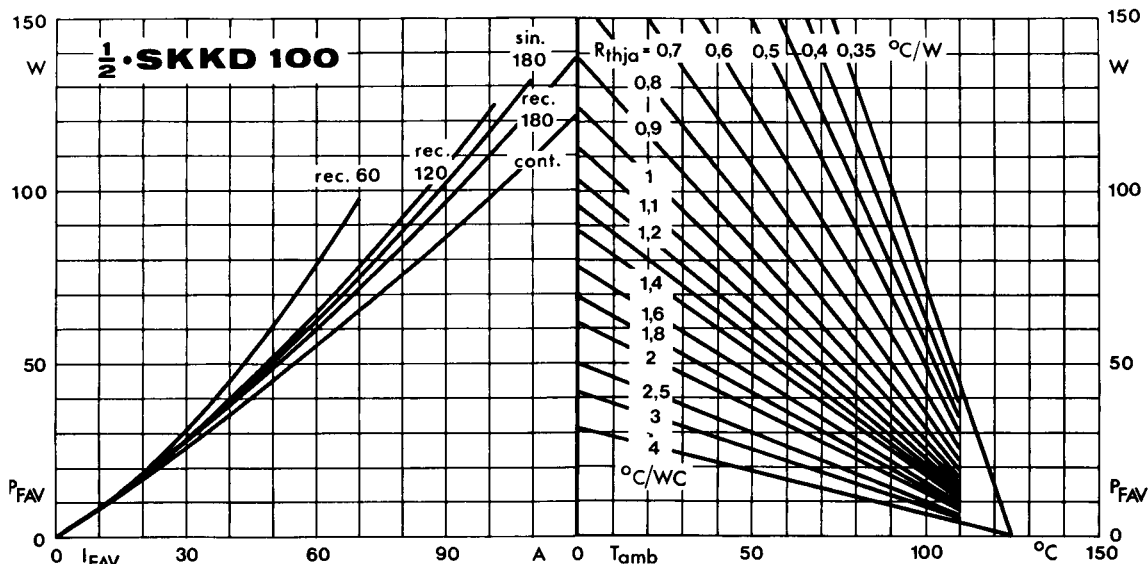

Fig. 11 a Power dissipation per diode vs. forward current and ambient temperature

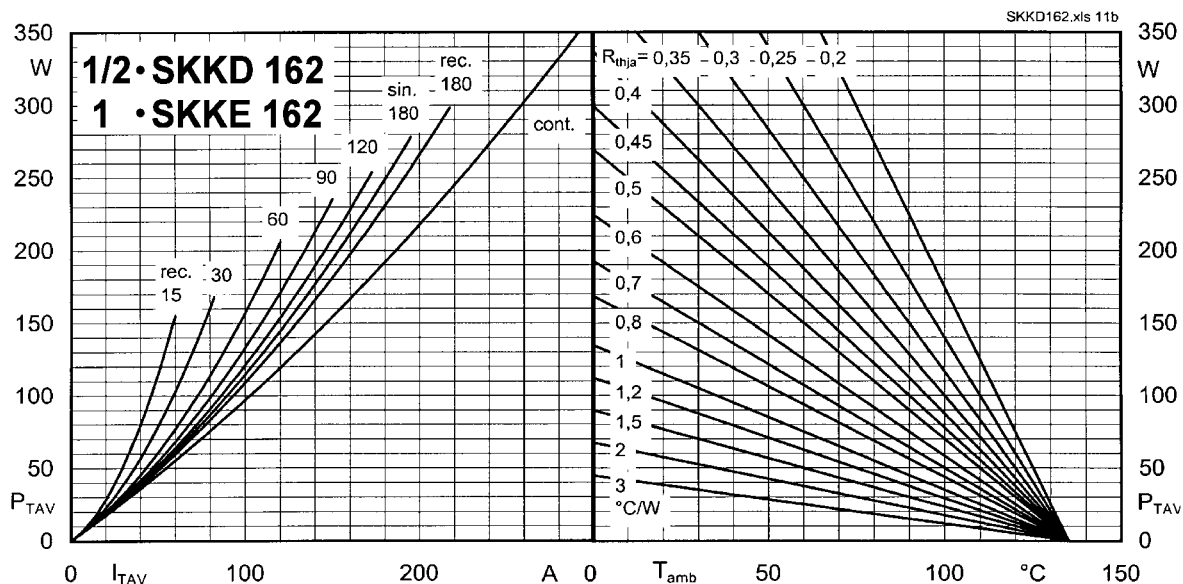

Fig. 11 b Power dissipation per diode vs. forward current and ambient temperature

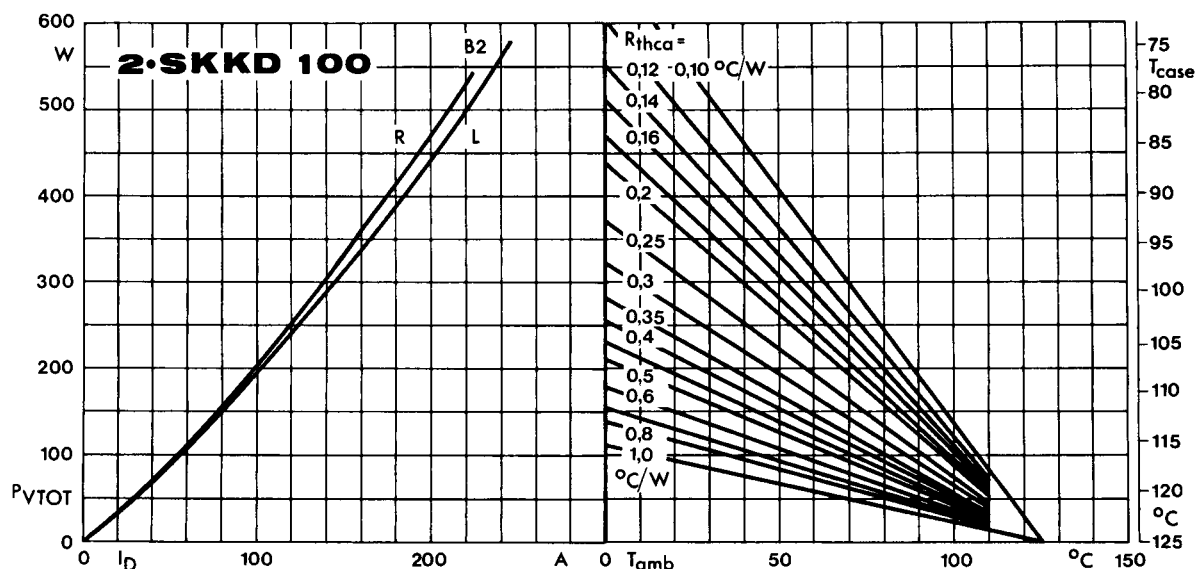

Fig. 12 a Power dissipation of two modules vs. direct current and case temperature

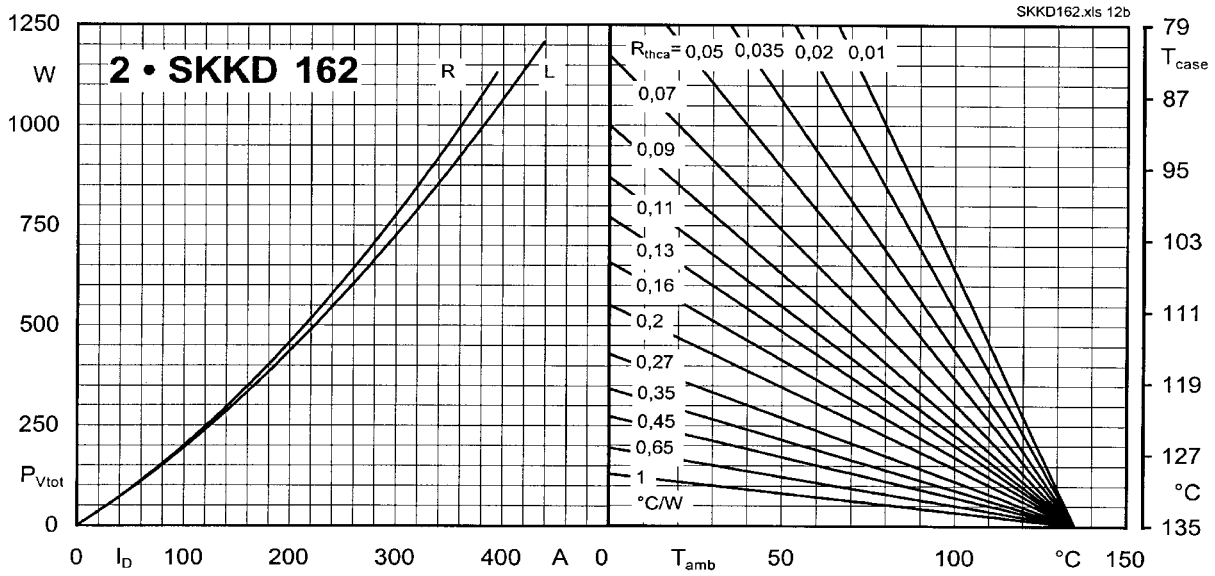

Fig. 12 b Power dissipation of two modules vs. direct current and case temperature

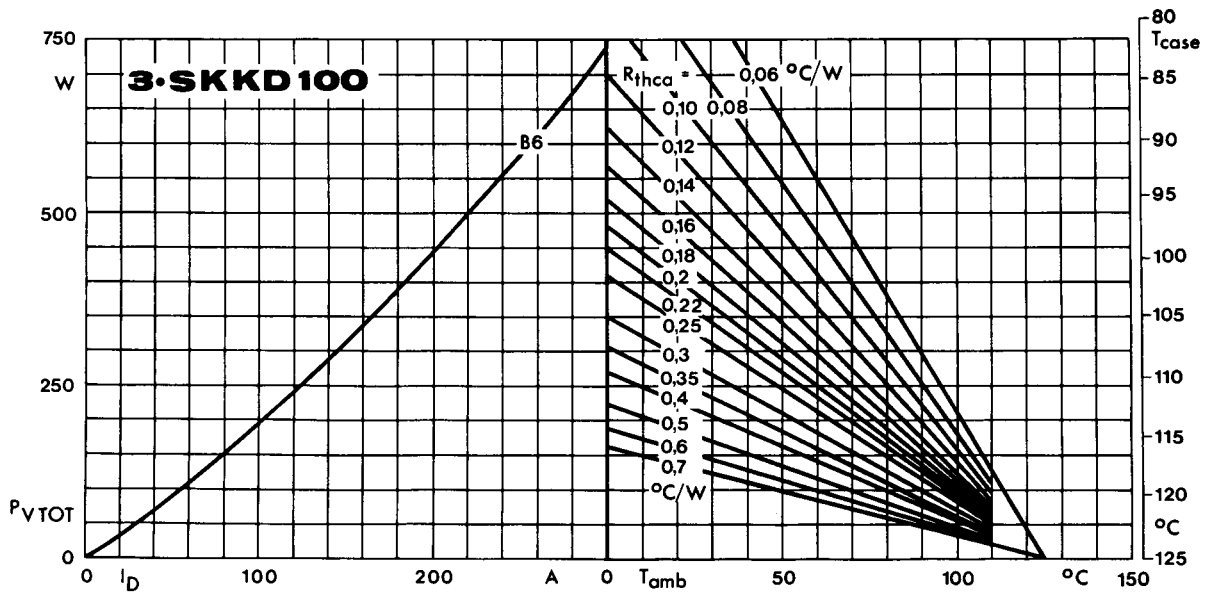

Fig. 13 a Power dissipation of three modules vs. direct current and case temperature

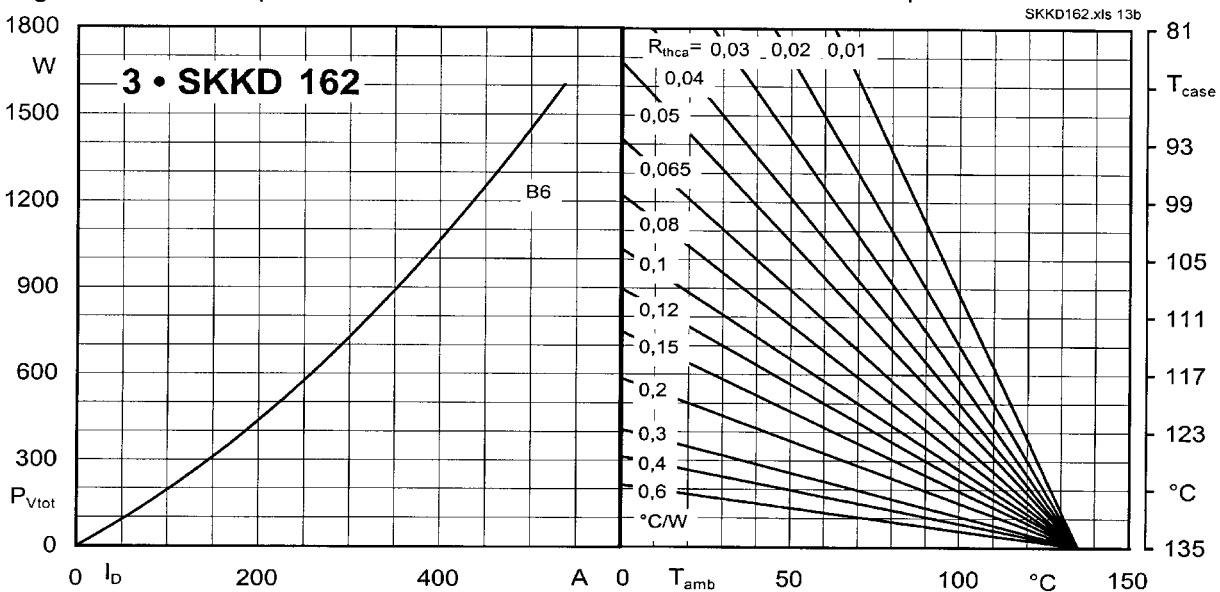

Fig. 13 b Power dissipation of three modules vs. direct current and case temperature

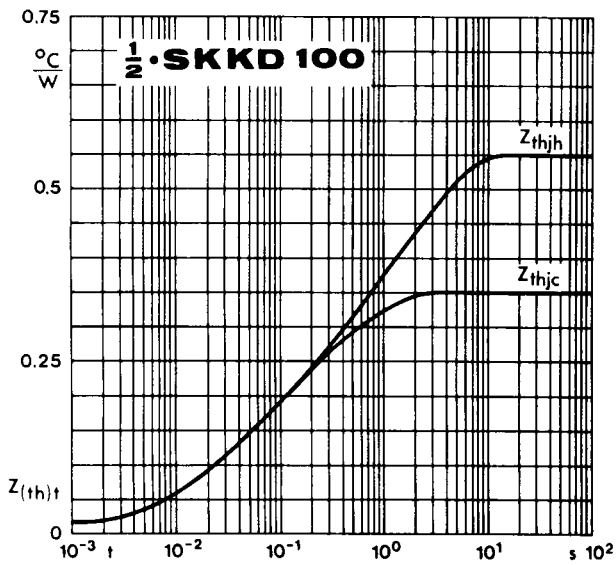

Fig. 14 a Transient thermal impedance vs. time

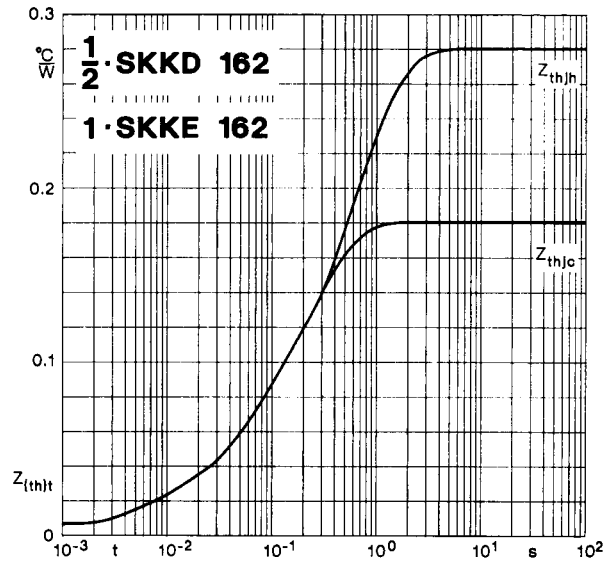

Fig. 14 b Transient thermal impedance vs. time

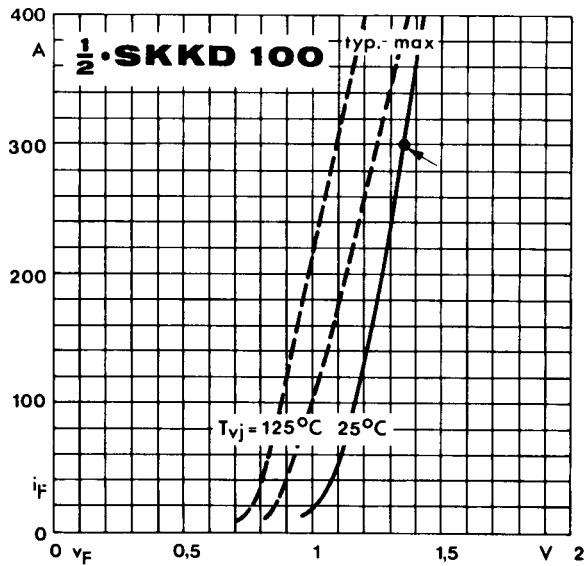

Fig. 15 a Forward characteristics

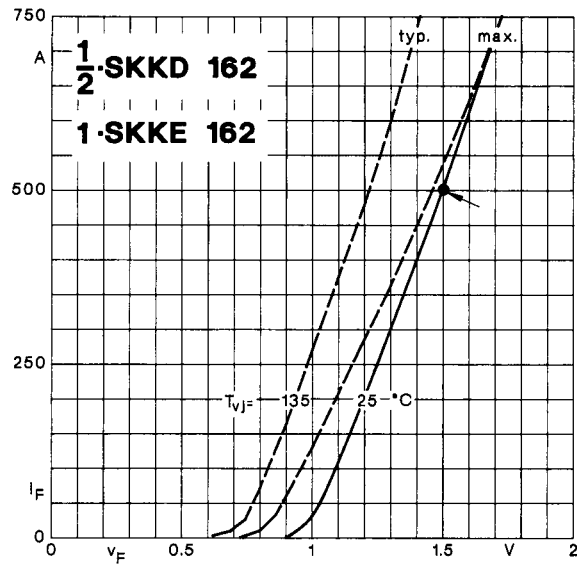

Fig. 15 b Forward characteristics

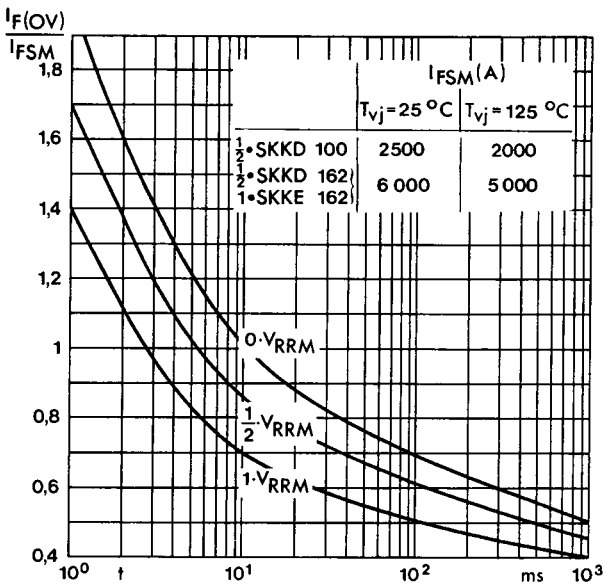

Fig. 16 Surge overload current vs. time

SKKT 19 ... 105

Case A 5

IEC 192-2: A 77 A

JEDEC: TO-240 AA

SEMIPACK® 1

UL recognized, file no. E 63 532



Dimensions in mm

SKKT 20/ ... 106/

Case A 46

IEC 192-2: A 77 A

JEDEC: TO-240 AA

SEMIPACK® 1

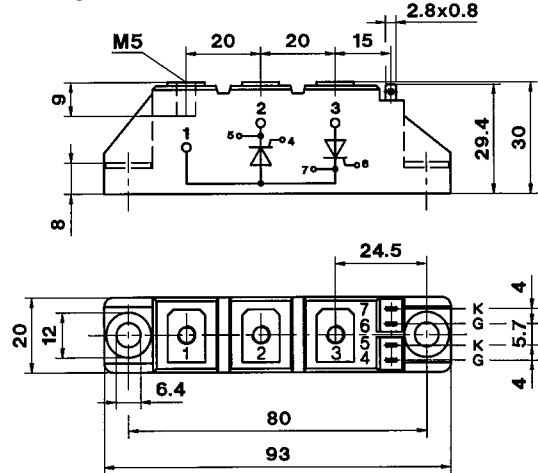

Dimensions in mm

SKKH 26 ... 105

Case A 6

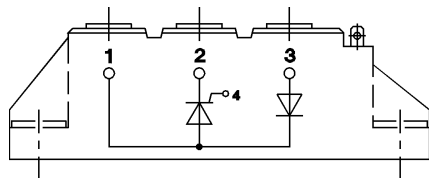

SKKD 26 ... 100

Case A 10

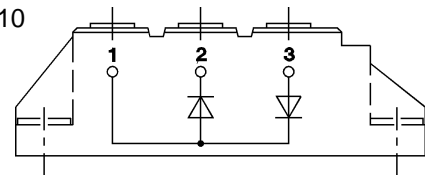

SKNH 56 ... 91

Case A 7

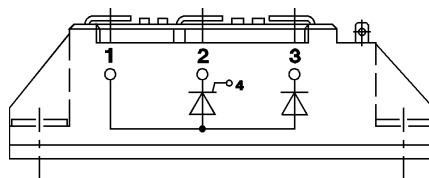

SKKE 81

Case A 12

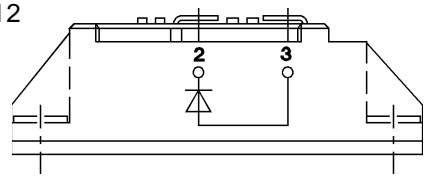

SKKL 56 ... 105

Case A 9

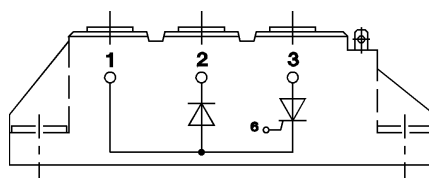

SKKH 27 ... 106

Case A 47

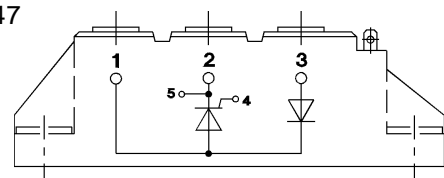

SKND 46 ... 81

Case A 19

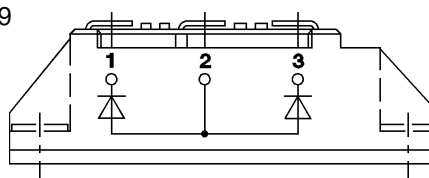

SKKT 20 B ... 106 B

Case A 48

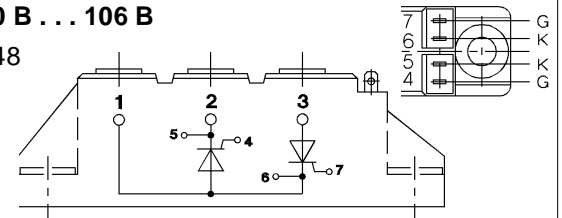

SKMT 92

Case A 72

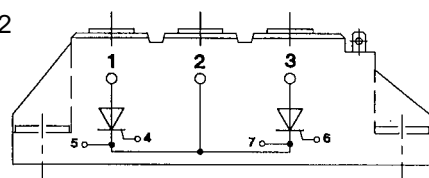

SKKL 42 ... 106

Case A 59

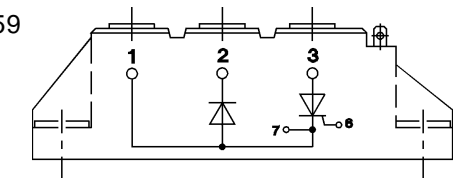

SKKT 122, 132, 162

Case A 21

SEMIPACK® 2

UL recognized, file no. E 63 532

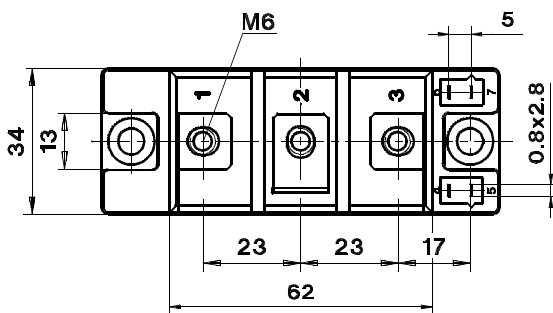
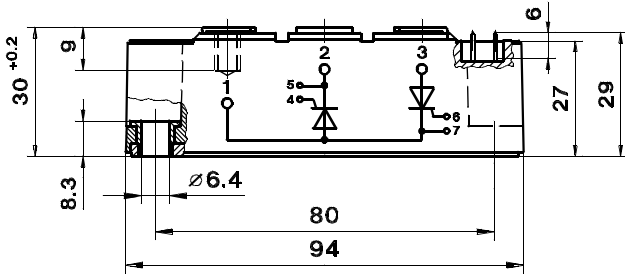
**SKMT 132**

Case A 50

SEMIPACK® 2

UL recognized, file no. E 63 532

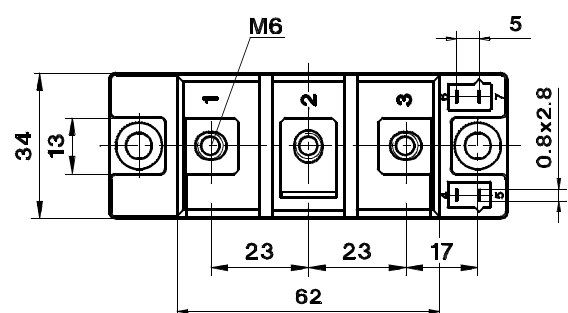
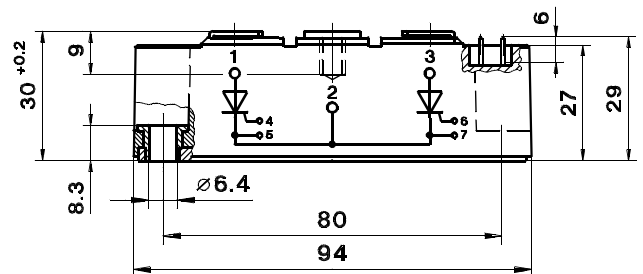
**SKKH 122, 132, 162**

Case A 22

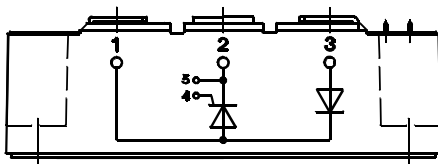
**SKND 165**

Case A 52

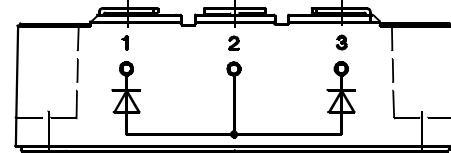
**SKKD 162**

Case A 23

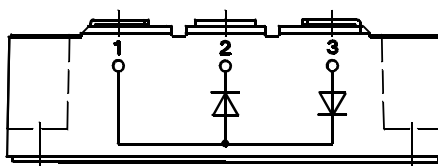
**SKND 162**

Case A 57

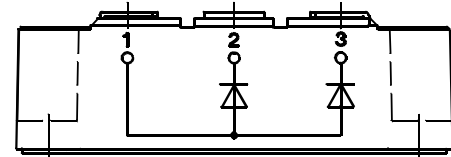
**SKKE 162**

Case A 24

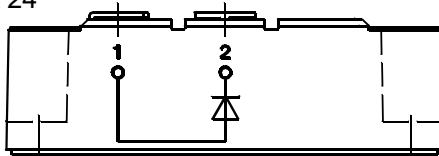

Dimensions in mm

SKNH 132

Case A 61

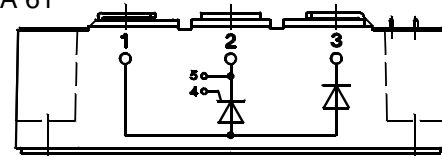

Dimensions in mm

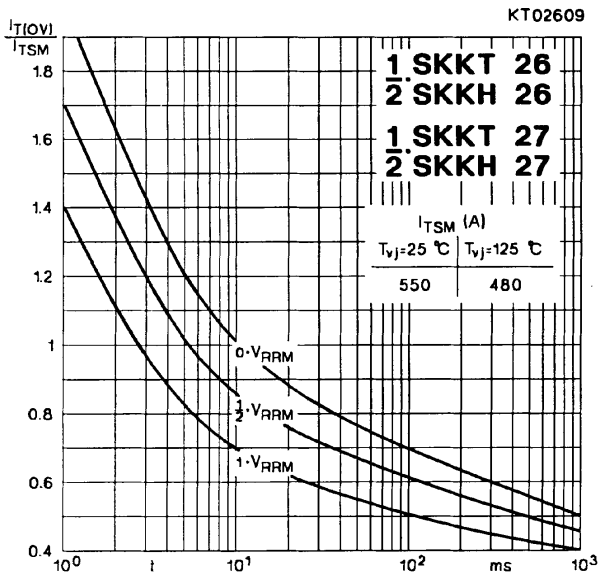

Fig. 9 Surge overload current vs. time

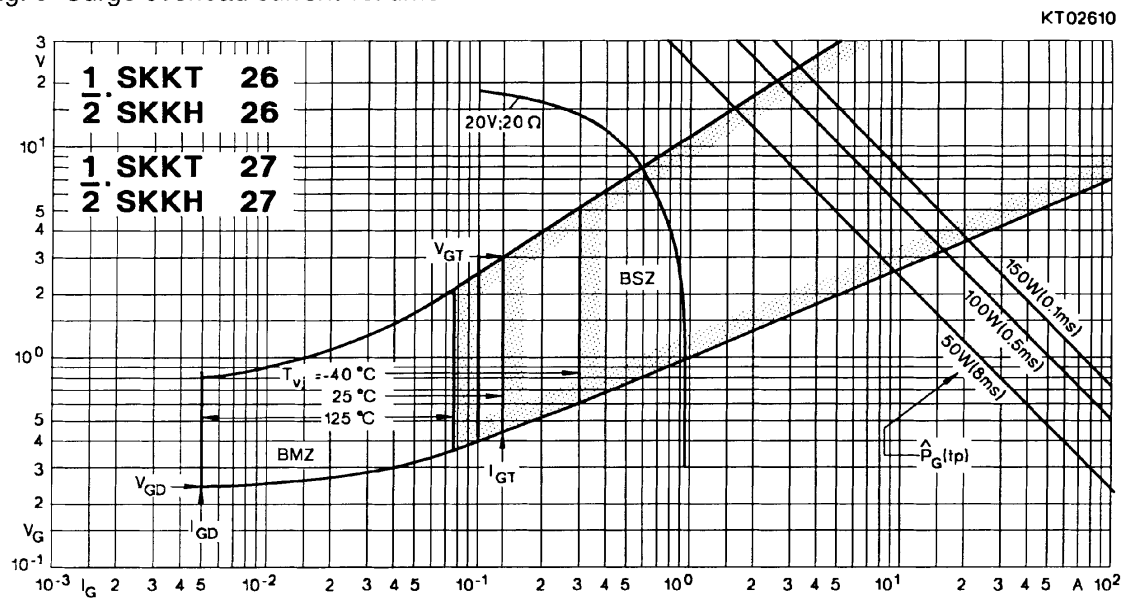

Fig. 10 Gate trigger characteristics

